





# OPERATING MANUAL

 <p><b>IBIZA</b></p>	 <p><b>MALTA</b></p>
 <p><b>MANHATTAN</b></p>	 <p><b>MIAMI</b></p>
 <p><b>PARIS</b></p>	 <p><b>SYDNEY</b></p>

## *Multi-mode commercial refrigeration equipment*

Copyright © AHT Cooling Systems GmbH. All Rights Reserved.

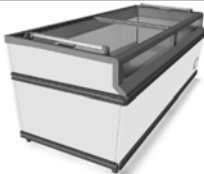
SNr. 372096

Status: 05/17



ISO 9001:2008, ISO 14001:2004, OHSAS 18001:2007, SA 8000:2008

Original operating manual. Keep for future reference.

## MODEL TYPES - OVERVIEW

### Multi-mode commercial refrigeration equipment

Model	Dimensions Length x Depth x Height		Maximum total weight unit *	
	[mm]	[in]	[kg]	[lb]
<b>IBIZA</b>				
100 NAM	1 000 x 851 x 925	39.37 x 33.50 x 36.42	95	209
145 NAM	1 456 x 851 x 925	57.32 x 33.50 x 36.42	115	254
<b>MALTA</b>				
145 NAM	1 456 x 855 x 833	57.32 x 33.66 x 32.80	125	276
185 NAM	1 851 x 855 x 833	72.87 x 33.66 x 32.80	150	331
<b>MANHATTAN</b>				
175 NAM	1 753 x 995 x 910	69.02 x 39.17 x 35.83	150	331
210 NAM	2 103 x 995 x 910	82.80 x 39.17 x 35.83	165	364
<b>MIAMI</b>				
145 NAM	1 457 x 854 x 833	57.36 x 33.62 x 32.80	115	254
185 NAM	1 850 x 994 x 834	72.83 x 39.13 x 32.83	145	320
210 NAM	2 102 x 854 x 833	82.76 x 33.62 x 32.80	160	353
250 NAM	2 502 x 854 x 833	98.50 x 33.62 x 32.80	180	397
<b>PARIS</b>				
145 NAM	1 457 x 853 x 833	57.36 x 33.58 x 32.80	110	243
185 NAM	1 854 x 853 x 833	72.99 x 33.58 x 32.80	140	309
210 NAM	2 102 x 853 x 833	82.76 x 33.58 x 32.80	160	353
250 NAM	2 502 x 853 x 833	98.50 x 33.58 x 32.80	175	386
<b>SYDNEY</b>				
175 NAM	1 752 x 993 x 910	69.98 x 39.09 x 35.83	180	397
213 NAM	2 132 x 993 x 860	83.94 x 39.09 x 33.86	175	386
223 NAM	2 232 x 993 x 860	87.87 x 39.09 x 33.86	180	397
230 NAM	2 302 x 993 x 910	90.63 x 39.09 x 35.83	205	452
250 NAM	2 502 x 993 x 910	98.50 x 39.09 x 35.83	215	474
XL 175 NAM	1 752 x 1 043 x 910	69.98 x 41.06 x 35.83	160	353
XL 210 NAM	2 102 x 1 043 x 910	82.76 x 41.06 x 35.83	205	452
XL 250 NAM	2 502 x 1 043 x 910	98.50 x 41.06 x 35.83	225	496

\*Execution-specific deviations possible. For details, please refer to the freight documents. These must be carried out by the operator.

Technical specifications are subject to change without notice.

**Table of contents**

MODEL TYPES - OVERVIEW .....	2
1 Safety.....	4
1.1 General information for the manual and safety .....	4
1.1.1 Limitation of liability .....	4
1.2 Explanation of symbols.....	4
1.3 Intended purpose.....	5
1.4 Staff requirements .....	6
1.5 Personal protective equipment.....	6
1.6 Specific hazards .....	6
1.6.1 Electricity .....	6
1.6.2 Refrigerant circuit.....	7
1.6.2.1 Flammable refrigerant .....	7
1.6.3 Mechanical hazards.....	8
1.6.4 Residual risks .....	9
2 Product description.....	10
2.1 General information .....	10
2.2 Technical data .....	10
2.2.1 Serial plate and serial number.....	10
2.3 Intended purpose.....	10
3 Layout and function .....	10
3.1 Automatic defrost.....	11
4 Operating and display elements.....	11
4.1 Temperature display .....	11
4.2 Operating panel and display elements .....	11
4.2.1 Electronic controller AHT (SECOP).....	11
4.2.1.1 Switch refrigeration function on/off .....	11
4.2.1.2 Setting selection .....	11
4.2.1.3 Semi-automatic defrost.....	12
4.2.1.4 Alarm indication and acknowledgment.....	12
5 Transport and storage .....	12
6 Unpacking.....	12
7 Setup and installation .....	13
7.1 Electrical connection.....	14
7.2 Electrical protection .....	14
8 Commissioning .....	15
9 Operation (use).....	15
9.1 Loading .....	16
9.2 Decommissioning and Re- commissioning .....	16
9.2.1 Decommissioning .....	16
9.2.2 Re-commissioning .....	16
9.3 Faults in operation .....	16
10 Maintenance .....	17
10.1 Cleaning.....	17
10.1.1 Basic cleaning.....	17
10.1.1.1 Cleaning steps during operation.....	17
10.1.1.2 Cleaning steps only with cooling function switched off (manual defrost) .....	18
10.2 Maintenance, service and repair .....	18
10.3 What to do if .....	19
10.4 Maintenance services.....	19
11 Disposal .....	19

# 1 Safety

## 1.1 General information for the manual and safety

This operating manual (hereinafter the “manual”) forms part of the device and enables a safe and efficient operation. The safety section provides information about important safety aspects for the protection of persons, things and materials. Task-related warnings/notes are contained in the individual chapters.

The complete manual can be found electronically on our website [www.ahtusa.net](http://www.ahtusa.net) or contact us at:

**AHT Cooling Systems USA, Inc.**

7058 Weber Blvd. • Ladson, SC 29456 • USA

**Phone:** +1 (0) 843/767 6855 **Fax:** +1 (0) 843/767 6858 **Email:** [info@us.aht.at](mailto:info@us.aht.at)

This manual is intended for the following **target groups**:

- **Operator**
- **Operating staff**
- **Qualified staff:** AHT service partner, AHT service technician, AHT customer service, AHT installation service, AHT assembly service

**Staff:** This term is used when the manual is addressed to all target groups.

This manual must be available and accessible to the local staff.

The staff must read the manual carefully before use.

All figures represent symbolic representations.

### 1.1.1 Limitation of liability

All the details in this manual were compiled in consideration of the standards and legal regulations applicable at this time, as well as the experience of the manufacturer and qualified staff. The manufacturer accepts no liability for damage to persons or things (devices, goods, etc.) resulting from:

- Non-observance of the manual and the regulations/safety instructions contained therein.
- Failure to comply with the local safety regulations.
- Inappropriate use (misuse)
- Use of unauthorized and non-trained staff.
- Unauthorized equipment conversions and technical modifications by the operator himself.
- Use of non-approved spare parts by the manufacturer.
- Failure of the power supply or electro technical safety devices.
- Typesetting and print errors.

Failure to observe the above points will invalidate the warranty claims.



The contractual obligations agreed to under the contract, the general terms and conditions of sale and delivery of the “AHT Cooling Systems GmbH” (hereinafter “AHT”) and the statutory provisions applicable at the conclusion of the contract apply.

Technical specifications are subject to change without notice.

The local commercial law regulations and safety regulations/provisions and the essential health and safety requirements of the unit apply.

## 1.2 Explanation of symbols

Safety and warning notices are indicated in this manual by **symbols** and **signal words**. Signal words refer to the risk level of the hazard.

Signal word	Meaning
 <b>WARNING</b>	Hazard with moderate risk level. Could result in danger to life or serious injury if not avoided.
 <b>CAUTION</b>	Hazard with low risk level. Could result in minor or moderate injury if not avoided.
 <b>NOTICE</b>	Individual notes or important collective notes to avoid material or property damage.

Symbol	Meaning	Symbol	Meaning
	General warning sign		Refer to instruction manual/booklet
	Warning: Electricity		Disconnect before carrying out maintenance or repair
	Warning: Electricity		Wear eye protection
	Do not connect damaged power cables to the circuit		Wear protective gloves
	Warning: Flammable material		Separate collection for electrical and electronic equipment
	Warning: Slippery surface		Marking of explosion protection
	Warning: Crushing of hands	-	listing
	Warning: Forklift trucks and other industrial vehicles	•	listing notice/ safety and warnings
	Warning: risk of tilting	▶	Action/Measure/Prohibition
	Warning: Low temperatures/ freezing conditions	→	Cross-reference to a different place in the document
	Warning: Hot surface		Unit-connection cable
	Do not walk or stand here		Light-connection cable
	Do not bore		
	Do not obstruct		

### 1.3 Intended purpose

- For storing, displaying or dispensing of pre-packed ice cream, pre-packed frozen or medium temperature foods depending on setting (see → chapter 2.2 and 2.3).
- The operator is responsible for the correct operation of the unit.
- Operate the unit in a stable position (horizontal alignment).
- Operate the unit only on the installed stilt or castors.
- Observe installation instruction see → chapter 7.
- Operate the unit only with glass lids.

#### **WARNING**

Hazards due to misuse.

- ▶ No technical modifications may be made to the unit.
- ▶ Steam or high-pressure cleaners may not be used for basic cleaning.
- ▶ Do not store explosive substances, e.g. aerosol containers with flammable propellant gas, in this unit.
- ▶ The unit may only be operated if all the required safety devices are present and fully functional.

#### **NOTICE**

- **Material and property damage** due to misuse.

- ▶ Do not exceed ambient conditions shown at the serial plate (see → chapter 2.2.1).

- ▶ The ambient temperature must not be less than 16°C (60.8°F).
- ▶ Regularly check that the unit is in good condition. Damage must be repaired immediately.
- ▶ Before storing the goods and during operation, the temperature must be checked for correctness (see → chapter 4.1).
- ▶ Stored goods must be checked by the operator in the case of power failure (temperature control).
- ▶ Check regularly for foreign objects in the goods area. Incorrectly stored goods must be removed immediately.
- ▶ Check regularly that the glass lids are closed.
- ▶ Operation of a unit with a broken glass lid/glass element (crack, break) is no longer possible.
  - Remove goods from the damaged unit and rearrange in a functional unit.
  - Switch off the damaged unit after removing the goods (decommissioning → see chapter 9.2).
  - Contact the maintenance service (see → chapter 10.4).
- ▶ Do not laminate glass surfaces with labels and foils.
- ▶ Observe the minimum distances to the boundary walls and to other units to avoid hindering the air circulation (see → chapter 7).
- ▶ Do not use glass lids as a storage for various objects.

## 1.4 Staff requirements

### ⚠ WARNING

Insufficient qualification. Risk of injury.

- ▶ All activities may only be performed by qualified staff.
- ▶ The staff must read and understand this manual before starting work.

#### Operator:

- The operator must ensure that this manual has been read and understood by the operating staff (training).
- The operator is responsible for the fact that faults during operation (e.g. alarms, temperature deviations, etc.) are recognized by the operating staff and appropriate measures are taken (→ see chapters 9.3 and 10.3).

#### Operating staff:

- The operating staff must be trained by the operator on the transferred tasks and possible dangers with the aid of this manual.
- Only trained operating staff are allowed to operate and clean the device.

#### Qualified staff:

- Only AHT-authorized, qualified staff and specialists are allowed to perform work on the unit, e.g.: Servicing (maintenance, service and repair).
- Only staff trained in handling flammable refrigerants may perform work on the refrigerant circuit of R-290 units.
- Only qualified electricians are permitted to work on the electrical system.

Persons (including children) with limited physical, sensory or mental abilities are allowed to operate the unit only under supervision and after instruction, and must not perform any maintenance work. Children must not play with the unit.

Working under the influence of alcohol and drugs is prohibited.

## 1.5 Personal protective equipment



#### Wear protective gloves

- ▶ Protection against heavy unit parts during unpacking, set up and installation and disposal.
- ▶ Protection against sharp edges, rotating parts and hot surfaces during maintenance, service and repair work.
- ▶ Protection from contact with fluid/leaking refrigerant in the case of a broken seal in the refrigerant circuit.
- ▶ Protection against low temperatures during loading and cleaning.
- ▶ When removing pieces of glass and glass splinters after glass breakage.



#### Wear eye protection

- ▶ Protection from contact with fluid/leaking refrigerant in the case of a broken seal in the refrigerant circuit.

## 1.6 Specific hazards

### 1.6.1 Electricity

Work on the electrical system may only be performed by qualified staff.

In the case of fault messages or damage to the unit, contact the maintenance service immediately (see → chapter 10.4).

### ⚠ WARNING



Contact with live parts may cause electric shock. Risk of fire due to sparks or overloading.

- ▶ Do not connect any damaged unit or damaged parts (e.g. power cables) to the circuit.
- ▶ Check the safety devices for completeness and functionality.
- ▶ Guards and covers on the unit must not be removed.



- ▶ Before connecting to power, note the following:
  - Applicable local electrical safety regulations
  - Applicable standards and safety notices.
  - Information on the serial plate (see → chapter 2.2.1).
- ▶ In the case of damage to the unit during operation and before maintenance work, observe the following safety rules:



1. Disconnect the unit (switch off all pins on all sides).
2. Secure the unit against restarting.

- ▶ Damaged parts must be replaced only by professionals, e.g.:

- power supply cables
- ▶ Do not squeeze or bend power supply cords.
- ▶ Do not use extension cords or multiple power strips.



- ▶ Steam or high-pressure cleaners may not be used for basic cleaning (see → chapter 10.1.1).
- ▶ Concealed electrical parts must not be damaged. Drilling or other work on the unit is not permitted.

## 1.6.2 Refrigerant circuit

Work on the refrigerant circuit may only be performed by qualified staff.

In the case of fault messages or damage to the unit, contact the maintenance service immediately (see → chapter 10.4).

### 1.6.2.1 Flammable refrigerant

**Safety and warning notes for units with flammable refrigerants.**

### ⚠ WARNING

- The refrigerant R-290 belongs to safety group A3 according to ASHRAE 34.  
The refrigerant used and the fill quantity are indicated on the power rating plate (see → chapter 2.2.1).
- The refrigerant is highly flammable.  
If leaks occur, the refrigerant can escape and create an explosive gas/air mixture. This can lead to fire and explosion with subsequent fire risk.



- ▶ Keep away from ignition sources (heat, sparks, open flames, hot surfaces).
- ▶ To remove condensation and for cleaning, use a damp cloth or sponge.  
Do not use dry clothes or sponges for rubbing dry.  
(Danger of electrostatic charging and sparking).

- Requirements for the installation area:
  - ▶ The device must only be installed in well-ventilated areas.
  - ▶ Do not install the unit in basements or lowered areas.
  - ▶ Ducts and wall penetrations must be sealed close to the unit in accordance with fire protection laws.
- Fluid refrigerant causes frostbite on the skin.
  - ▶ Protect hands and face from contact with fluid/leaking refrigerant.
  - ▶ Wear protective goggles and gloves.
- Do not close the air vents in the unit housing. Use only original accessories.
- To accelerate the defrosting process, do not use any mechanical devices or other means (e.g. ice scrapers).
- Do not damage the refrigerant circuit.
  - ▶ Do not expose the unit during storage and transport to temperatures higher than 70°C (158°F).
  - ▶ Avoid transmission of pulsations and vibrations to the unit.
  - ▶ Avoid external force upon the unit such as careless movements with forklift trucks or floor cleaning machines.



- ▶ Drilling or other work on the unit is not permitted.
- ▶ Do not squeeze or bend pipes



- Do not operate any electrical devices (e.g. wet vacuum cleaners) within the refrigerator compartment that are not of the type recommended by the manufacturer. Devices with explosion protection markings (see → chapter 1.2) are permitted.
- Steam or high-pressure cleaners may not be used for the basic cleaning (see → chapter 10.1.1).
- Work on the electrical system and the cold system must only be performed by qualified staff (staff trained in flammable refrigerants).
  - ▶ Opening the refrigerant circuit and suctioning of the refrigerant may only be performed in a well-ventilated area outside of business hours of the market (without customer traffic) or outdoors.
  - ▶ Disconnect the unit before each maintenance/repair (see → chapter 9.2).
  - ▶ Secure the unit against restarting.
  - ▶ During repairs, a knowledgeable person who knows the local conditions must be available, as the contact person, for the authorized AHT experts.
- Dispose of units with flammable refrigerant and units with insulating foam (thermal insulation polyurethane foam with pentane) appropriately. Inquire with the responsible authorities about the safety and statutory disposal regulations applicable to you.



The product was designed to take into account the environmental and disposal friendliness of AHT units. The refrigerant R-290 and the propellant pentane (for the insulating foam) do not have any ozone depletion potential and do not contribute directly to the greenhouse effect.

### 1.6.3 Mechanical hazards

#### ⚠ WARNING



- Transport the unit with forklift trucks. Risk of injury to persons during collisions.
  - ▶ Observe the transport routes for forklift trucks.
  - ▶ Secure the cargo.
  - ▶ Forklift trucks must only be operated by trained persons.



- Danger of tilting of the unit. Persons can be pinched (see → chapter 7).
  - ▶ Do not climb onto or into the unit.



- Disposal of packaging material and films. Danger of suffocation.
  - ▶ Keep packaging material and foils away from children.
  - ▶ Do not let children play with them.
- Missing and/or not fully functional safety devices. Danger of injury due to e.g. rotating parts.
  - ▶ Check the safety devices for completeness and functionality.
  - ▶ Guards and covers on the unit must not be removed.

#### ⚠ CAUTION



- Cutting injuries in the case of material breakage. Danger of falling.
  - ▶ Do not climb onto or into the unit.



- Falling objects. Impact injury. Cutting injury in the case of glass breakage.
  - ▶ Do not place objects on the unit



- Leakage of defrosted water. Slipping hazard.
  - ▶ Check for puddle formation in front of and below the unit.
  - ▶ Remove spilled defrosted water immediately.



- Opening/Closing the glass lids. Hands (body parts) can be pinched.
  - ▶ During opening/closing do not grip the gaps.
  - ▶ When opening/closing pay attention to other people.



**⚠ CAUTION**

- Glass breakage hazard. Cutting injuries to the body. Impact injury.
  - ▶ Do not install units with multi-pane insulating glass at altitudes above 2000 m (6562 ft). Multipane insulating glass can break due to air pressure differences.
  - ▶ Do not apply a load onto the glass lids.
  - ▶ Check for damage (crack, fissure, breakage) of the glass lids/glass elements. In the event of damage, contact the maintenance service immediately (see → chapter 10.4).
  - ▶ Do not climb onto or into the unit.
  - ▶ It is prohibited to store glass containers when operating below 0°C (32°F).
  - ▶ Check breakage of glass containers when operating above 0°C (32°F).
- Disposal of broken glass. Cutting injuries to hands.
  - ▶ Wear protective gloves to remove splintered glass parts and the possibly damaged goods.
  - ▶ Remove all splintered glass parts and damaged goods carefully and completely.



Dispose of splintered glass parts in an environmentally friendly manner.

### 1.6.4 Residual risks

The manufacturer assumes no liability for any damage caused by failure to observe these instructions.

## 2 Product description

### 2.1 General information

In the product design, the manufacturer has considered the environmental and disposal-friendliness of the device, in particular, for the refrigerant propane (R-290) and the propellant pentane (for the insulating foam). Propane does not have any ozone depletion potential (ODP) and only a very low Global Warming Potential (GWP) of 3.



### 2.2 Technical data

Important technical data can be found on the serial plate (see → chapter 2.2.1).

- External dimension	See → Model-Types overview
- Maximum total weight unit	
Airborne noise emissions	Emission sound pressure level < 70 dB(A)

Application/Operating mode	Setting
Customer specific	A1
Customer specific	A2
Refrigerator	A3
Freezer	A4
Ice cream freezer	A5

#### Technical interfaces

<b>Power supply</b>	AC 110-120V / 1PH/ 60 Hz
<b>Connector types</b>	NEMA L5-15 NEMA 5-15
<b>Power cord or IEC-box with plugged-in cables</b> (see → chapter 7.1)	
Unit – connection cables 	Labeling flag with snowflake
Light-connection cables 	Labeling flag with lamp
combined Unit/Light-connection cables	No labeling flag
<b>Minimum requirement for power cords</b>	
Minimum cross-section	18AWG
cabling	3-pin cable

#### Electrical protection (see → chapter 7.2)

Fuses	Rated current [A]	Triggering characteristics	Type	Fault current [mA]
	for 110-120V			
<b>CB</b>	15	C (time-lag)	–	–
<b>GFCI</b>	≥ 40	–	Surge current strength, short-time delayed (e.g. G/AP-R)	30
<b>RCBO</b>	15	C (time-lag)	Surge current strength, short-time delayed (e.g. G/AP-R)	30

Customized deviations possible.

Further information: Maintenance services (see → chapter 10.4).

### 2.2.1 Serial plate and serial number

When handling the unit, the information on the serial plate must be observed. The serial plate is located on the back side of the unit and contains important technical data:

- Model,
- Serial number (see → chapter 10.4),
- Recommended operating ambient temperature\* (see → chapter 1.3),
- Nominal voltage /frequency,
- Nominal consumption
- Nominal current,
- Refrigerant and quantity,
- Date of production,
- Certification marks,
- Further technical data

\*These units are designed to meet ANSI/ NSF® Standard #7 requirements in air conditioned stores, where temperature is maintained at or below the specified levels and relative humidity is maintained at or below 55%. Proper installation is required to maintain certification.

Levels specified at serial plate	Recommended operating ambient temperature
Type I (75°F/24°C)	Between 16°C (61°F) and 24°C (75°F)
Type II (80°F/27°C)	Between 16°C (61°F) and 27°C (80°F)

### 2.3 Intended purpose

For storing, displaying or dispensing of pre-packed ice cream, pre-packed frozen or medium temperature foods depending on setting (setting see → chapter 2.2). Further information see → chapter 1.3

## 3 Layout and function

The equipment is a self contained plug-in unit. All individual units are delivered ready for operation and have their own control unit. All units are delivered with a customer specific factory setting. Each unit contains one or more hermetically sealed refrigerant circuits, the components of which are technically connected to each other permanently. The units can operate in 5 different operating modes (see → chapter 4.2.1.2):

- Two settings „Customer specific“,
- Refrigerator,
- Freezer or
- Ice cream freezer.

The waste heat generated in the unit is discharged to the ambient air via an air condenser.

The unit is defrosting automatically to keep the inner tank free of frost and ice. The unit works properly even when the frost/ice accumulates on the surface of the inner tank. Automatic defrost and the button **[MAN. DEFROST]** for semi-automatic defrost are set inactive in freezer mode.

A limited number of semi-automatic defrosts can be performed (see → chapter 4.2.1.3). Depending on the setting, individual variations of interior equipment (air ducts, floor grilles, partition grilles, standing baskets) are possible.

**NOTICE**

- **Property damage** due to missing interior.
  - ▶ Wall grills must be used in every setting.
  - ▶ Never operate in refrigerator setting without air ducts and floor grills.

All units are equipped with load lines (see → chapter 9.1). All units are classified in the equipment family horizontal closed transparent (HCT).

**3.1 Automatic defrost**

Triggered by a factory-set time, the unit starts one defrost cycle per week (during night time).

Defrost cycle stops automatically when ice/frost is removed (triggered by the internal temperature sensor or software based max. time out period).

During automatic defrost the display shows “dEF” (see → chapter 4.2.1).

The accumulated defrost water is drained to the engine room and gets evaporated.

**⚠ CAUTION**



- Leakage of defrosted water. Slipping hazard.
- ▶ Check for puddle formation in front of and below the device.
  - ▶ Remove spilled defrosted water immediately.
  - ▶ Contact maintenance services (see → chapter 10.4) immediately.

**4 Operating and display elements**

**4.1 Temperature display**

**Indication of indoor temperature:** (see → chapter 4.2.1).

**Indoor temperature check:**

Responsibility: operating staff  
Frequency: several times a day

**4.2 Operating panel and display elements**

To get to the operating panel, remove the protection acrylic cover with a screwdriver.

**⚠ CAUTION**

- Removal of the protection acrylic cover with a screwdriver. Stab injury.
- ▶ Carefully handling with tool.
  - ▶ Select the proper size of the screwdriver to avoid slipping.
  - ▶ After use ensure that the screwdriver is kept neatly and safely.

**NOTICE**

- **Property damage** due to incorrect parameter changes.
  - ▶ Reinstall protection acrylic cover after operation.

**4.2.1 Electronic controller AHT (SECOP)**

Three buttons are available as control elements.



Fig.1: Electronic controller

Nr.	Control element	Function
1	Button [+/-]	- Change of setting (e.g. A1,A2)
2	Button [MAN. DEFROST]	- Semi-automatic defrost
3	Button [STANDBY RESET]	- Manual defrost - Switch on/off refrigeration function - Error code selection (when red light is on) - Acknowledge acoustic alarm

Nr.	Display	Meaning
4	luminous red dot on	alarm

**4.2.1.1 Switch refrigeration function on/off**

Switch off (manual defrost):

- Press Button [STANDBY RESET] for at least 3 seconds.
- „---“ is shown at the display.

Switch on:

- Press Button [STANDBY RESET] for at least 3 seconds.
- At the display the current temperature is shown.

**4.2.1.2 Setting selection**

Available settings (see → chapter 2.2)

Show current setting:

- Press button [+/-] briefly.
- e.g. „A1“ is shown at the display.

Change setting:

- By pressing button [+/-] several times, all available settings can be addressed.

Confirm shown setting:  
Wait 5 seconds.

### 4.2.1.3 Semi-automatic defrost

Start semi-automatic defrost:

Press button **[MAN. DEFROST]** briefly  
 „DEF“ is shown at the display during entire defrost cycle.

When the semi-automatic defrost is finished it returns to normal operation. At the display the current temperature is shown.

#### 84-hour-defrost locker:

If „---“ is shown on the display, the defrost locker is activated.

### 4.2.1.4 Alarm indication and acknowledgment

#### Alarm indication:

The **error code** is flashing alternatingly with the current temperature. Simultaneously the red dot (see → Fig. 1 Nr.4) is on.

Some units are equipped with an **acoustic alarm**.

#### Alarm acknowledgment:

##### Error code and acoustic alarm:

Press button **[STANDBY RESET]** briefly.

On the display the current temperature and the red dot is on. The red dot (see → Fig.1 Nr.4) remains until the error is corrected.

#### Recall error code:

Press button **[STANDBY RESET]** briefly.  
 Error code is shown for 5 seconds on the display. Afterwards the current temperature is shown.

#### Error codes:

Error code	meaning
F1	Sensor error
F2	Sensor error
F4	Sensor error
A90	Check clock settings
E20	High temperature alarm
E21	Evaporator temperature too high
E43	Low temperature alarm
E60	Temperature logger high alarm
E70	Electronic failure
E75	Controller temperature too high
E80	Motor error
E92	Compressor stop due to too high Controller temperature
E93	Mains supply voltage out of range
E95	Mains supply frequency out of range
Err	Display communication error
tst	Elektronics in test mode

## 5 Transport and storage

Examine the unit for transport damage after delivery. Contact the maintenance service in case of damage (see → chapter 10.4).

### ⚠ WARNING



Damage to refrigerant circuit. The refrigerant can escape and create an explosive gas/air mixture. Risk of fire.  
 ► Do not expose the device during storage and transport to temperatures higher than 70°C (158°F).  
 ► Ensure good ventilation  
 ► Observe the safety and warning signs for devices with flammable refrigerants (see → chapter 1.6.2.1).  
 ► If the unit is damaged contact the maintenance service (see→ chapter 10.4).

### ⚠ WARNING



Transport the unit with forklift trucks. Risk of injury to persons during collisions.  
 ► Follow the transport routes of forklift trucks.  
 ► Secure the cargo.  
 ► Forklift trucks must only be operated by trained persons.  
 ► Follow maximum stacking heights on packaging.

### NOTICE

- **Material damage** due to transport und storage.
  - Do not expose the unit during storage and transport to temperatures higher than 70°C (158°F).
  - Transport and store the unit only in the position of use.
  - Do not mix different types when you stack one unit above the other.
  - If the device was inclined during transport, wait a minimum of 2 hours before commissioning.
  - When delivering, ensure continuous accessibility up to the installation room. (Observe the transit heights/widths/installation space height and adequate shunting radii.)

## 6 Unpacking

Check the unit for damage (bumps, scratches) before and during unpacking. Contact the maintenance service in case of damage (see → chapter 10.4).

### ⚠ WARNING

Disposal of packaging material and films. Danger of suffocation.  
 ► Keep packaging material and foils away from children.  
 ► Do not let children play with them.

### ⚠ WARNING



Damage to the refrigerant circuit. The refrigerant can escape and create an explosive gas/air mixture. Risk of fire.  
 ► Ensure good ventilation.  
 ► Observe the safety and warning signs for devices with flammable refrigerants (see → chapter 1.6.2.1).  
 ► If the unit is damaged contact the maintenance service (see→ chapter 10.4).

**⚠ CAUTION**



Heavy unit components. Cutting injuries to the hands. Hands can be jammed.

- ▶ When unpacking, take care with fingers and hands.



- ▶ Wear protective gloves.

**NOTICE**

- **Material and property damage** due to missing components of the unit.
  - ▶ Check for loose components in the packaging.
  - ▶ Do not dispose of loose components. If it cannot be determined where the loose components belong, check with the maintenance service (see → chapter 10.4).

**7 Setup and installation**

The setup and installation of a unit can be conducted by the operator.

For technical data for interfaces, see → chapter 2.2. Technical modifications to the device can only occur with the coordination and approval of the manufacturer.

**NOTICE**

- **Material and property damage** due to congestion of the warm exhaust air (heat accumulation).
  - ▶ The exhaust air must be able to escape freely at the backside of the unit.
  - ▶ Minimum distance for single unit installation
    - All around: 100 mm (3.9 in)
  - ▶ Minimum distance for island arrangement (see → Fig.2.)
    - A= 0 mm (0 in)
    - B= 100 mm (3.9 in) /155 mm (6.1 in) (type-specific)

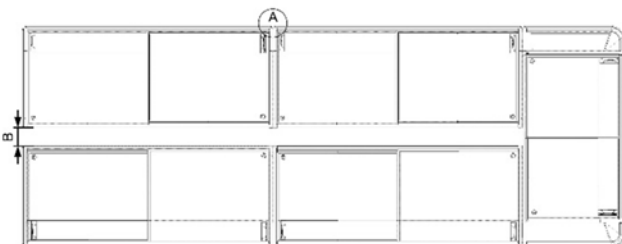

Fig. 2: Minimum distance for island arrangement

- ▶ The air vents of the unit-cover must not be covered for island arrangement.
  - ▶ Superstructures can be attached only in agreement with the manufacturer.
- Minimum distance 100 mm (3.9 in).

The temperature display, safety instructions and serial plate (see → chapter 2.2.1) must always be kept clear.

**⚠ WARNING**



Danger of tilting of the unit. People's bodies can be jammed.

- ▶ Remove the transport pallet only when the stable, final installation position has been reached. If you have questions, contact the



maintenance service (see → chapter 10.4).  
▶ Do not climb onto or into the device.

**⚠ WARNING**



If the refrigerant circuit is damaged, the refrigerant can escape and create an explosive gas/air mixture. Risk of fire.

- ▶ Do not close the air vents in the unit housing. Use only original accessories.
- ▶ The unit must only be installed in well-ventilated areas.
- ▶ Do not install the unit in basement or lowered areas.



▶ Ducts and wall penetrations must be sealed close to the unit in accordance with fire protection laws.  
▶ Drilling or other work on the unit is not permitted.

**⚠ CAUTION**



Cutting injuries in the case of material breakage. Danger of falling.  
▶ Do not climb onto or into the unit.

**⚠ CAUTION**



Heavy units. Hands can be jammed.  
▶ During setup and installation, pay attention to fingers and hands.



- ▶ Wear protective gloves.

**NOTICE**

- **Material and property damage** due to misuse.
  - ▶ Setup the unit only in the position of use. Do not remove existing stilt/castors.
  - ▶ Do not expose the unit to heat radiation at the installation site.
  - ▶ Do not expose the unit to warm air current.
  - ▶ Do not attach thick, insulating materials to the unit. Advertising posters may only be thin foils.

**Installation tasks for operator:**

- Block castor brake (if castors are present).
- Installation and removal of glass lids: The removal and installation can be necessary for cleaning purposes.

Glass safety instructions see → chapter 1.6.3.

**Units with glass sliding lids**

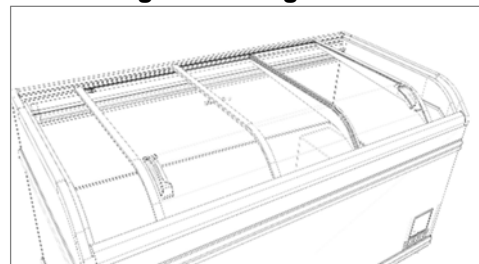

Fig.3: Unit with glass sliding lids

**Removal of glass sliding lids**

1. Open upper sliding lid.
2. Start lifting upper sliding lid with both hands and pull it out of the upper track.
3. Remove carefully with both hands.
4. Ensure proper and safe storage.



**Installation of glass sliding lids**

1. Insert smaller, lower sliding lid.
2. Insert upper sliding lid.
3. Fully close the lids.
4. Check for smooth functionality.

**7.1 Electrical connection**

The connection to the power supply is provided by the operator. For technical data, see → chapter 2.2.

**⚠ WARNING**



Connect the unit to the power supply. Contact with live parts may cause electric shock. Risk of fire due to sparks or overloading.



▶ Work on the electrical system may only be performed by qualified staff.

▶ Refer to the local electrical safety regulations.

▶ Follow the applicable standards and safety instructions.

▶ Follow the information on the serial plate (see → chapter 2.2.1). The network voltage and the network frequency must match the specifications on the serial plate.

▶ Do not connect any damaged unit to the power circuit.

▶ Damaged parts (such as power cords) must only be replaced by trained staff.

Contact the maintenance service (see → chapter 10.4).

▶ Do not squeeze or bend power supply cords.

▶ Observe the minimum requirement for connection cables (see → chapter 2.2).

▶ The unit must be electrically protected according to the applicable laws and regulations and the requirements of AHT (see → chapter 7.2).

▶ Connect the unit only to a network circuit with protective grounding.

▶ Do not use extension cords or multiple power strips.

▶ Concealed electrical parts must not be damaged. Drilling or other work on the device is not permitted.



**NOTICE**

• **Material and property damage** caused by non-AHT-approved deviations (voltage, frequency) in the operator's electrical network.

▶ The manufacturer is not responsible for damage to the electrical unit of the operator and the subsequent damage caused thereby.

• **Material and property damage** due to a wrong electrical connection.

▶ Load shedding circuits or device shutdowns are not permitted.

**Unit-connection cable**

At the end of the unit-connection cable you can find a labeling flag with a snowflake.



Fig. 4. Symbol snowflake

The unit-connection cable is used for cooling purposes.

**NOTICE**

• **Property damage** due to missing connection (cooling).

▶ Do not connect the unit-connection cable to the power supply of the ambient light.

**Light-connection cable (optional)**

At the end of the light-connection cable you can find a labeling flag with a lamp.



Fig. 5. Symbol lamp

**Unit/Light- connection cable:**

No labeling flag.

**NOTICE**

• **Property damage** due to missing connection (cooling).

▶ Unit/Light- connection cable requires permanent power supply.

**Units with IEC-Box**

For technical data, see → chapter 2.2.

Units can be equipped with a so-called IEC-Box.



Fig.6: IEC-Box

**⚠ WARNING**



Wrong electrical connection to the IEC-Box. Contact with live parts may cause electric shock. Risk of fire due to sparks or overloading.



▶ The brackets of the IEC-Box must be properly fixed and secured by the screw holder (see → Fig.6).

AHT recommends (e.g. island arrangement) the usage of a cable duct with internal or external sockets. In the case of floor mounting, do not exceed lower edge of the ventilation grille on the backside.

**7.2 Electrical protection**

Each electrical supply circuit must be equipped with appropriate protection means according to National requirements and local regulations.

For technical data, see → chapter 2.2.

**⚠ WARNING**



Faulty/inadequate electrical fuse. Contact with live parts may cause electric shock. Risk of fire due to sparks or overloading.



▶ Provide adequate protection.

▶ Observe applicable local requirements (for example, for electrical installation and operating of the device).

▶ Follow the applicable standards and

safety instructions.

- ▶ Never connect more than 2 devices to a Circuit Breaker (CB). AHT recommends one device only.

One of the following electrical fuses must be used:

- Circuit Breaker (CB) in combination with Ground Fault Circuit Interrupter (GFCI)
- Residual current operated Circuit-Breaker with Overcurrent protection (RCBO).

Observe the applicable standards such as:

- NEC 70

## 8 Commissioning

The unit must only be commissioned in the intended installation room and after checking for completeness. The commissioning of a unit can be conducted by the operator.

### ⚠ WARNING



Damage to the electrical system and/or the refrigerant circuit. Contact with live parts may cause electric shock. The refrigerant can escape and create an explosive gas/air mixture. Risk of fire due to sparks or overloading.



- ▶ Do not commission a damaged device.



- ▶ Do not connect damaged parts to the circuit (such as power cords).

- ▶ Damaged parts (such as power cords) must only be replaced by trained staff.
- ▶ Observe the safety and warning signs for devices with flammable refrigerants (see → chapter 1.6.2.1).

- ▶ If the unit is damaged contact the maintenance service (see→ chapter 10.4).

### NOTICE

- **Property damage** due to incorrect ambient conditions
  - ▶ Adjust the unit to the ambient temperature before commissioning.
  - ▶ The ambient temperature must not be less than 16°C (60.8°F).

Plug in the unit-connection cable or unit/light-connection cable.

The cooling cycle starts working after a short delay of max. 2 min.

If the operator retrofits a unit with internal LED-lighting, the light-connection cable must be plugged in.

Choose desired operating mode see → chapter 4.2. 3-4 hours after commissioning the desired temperature can be achieved.

## 9 Operation (use)

Only trained operating staff are allowed to operate the device.

### ⚠ WARNING



Damage to the electrical system and/or the refrigerant circuit during operation. Contact



with live parts may cause electric shock. Risk of fire due to sparks or overloading. The refrigerant can escape and create an explosive gas/air mixture. Risk of fire.



- ▶ If the unit is damaged.
  1. Disconnect the unit.
  2. Secure the unit against restarting.
 Contact the maintenance service (see→ chapter 10.4)

- ▶ Observe the safety and warning signs for units with flammable refrigerants (see → chapter 1.6.2.1).

- ▶ Avoid external force to the unit such as careless movements with floor trucks or floor cleaning machines.

- ▶ Avoid transmission of pulsations and vibrations to the unit.

### ⚠ CAUTION

Cutting injuries in the case of material breakage. Danger of falling.



- ▶ Do not load glass lids.
- ▶ Do not climb onto or into the unit.
- ▶ Check for damage to the glass elements and plastics. If the unit is damaged contact the maintenance service (see→ chapter 10.4).
- ▶ Check breakage of glass containers when operating above 0°C (38°F).

### ⚠ CAUTION



Disposal of broken glass. Cutting injuries to the hands.



- ▶ To remove the glass splinters and the goods possibly damaged by them, wear protective gloves

- ▶ Remove all glass splinters carefully.

### NOTICE

- **Material damage** due to misuse.
  - ▶ Operate the unit only in the position of use (horizontal).
  - ▶ Operate the unit only with existing stilt/casters.
  - ▶ Regularly check that the unit is in good condition. Damage must be repaired immediately.
  - ▶ Avoid transmission of pulsations and vibrations to the unit.
  - ▶ Avoid external force to the device such as careless movements with forklift or floor cleaning machines.
- **Property damage** due to misuse.
  - ▶ Do not exceed ambient conditions shown at the serial plate (see → chapter 2.2.1).
  - ▶ The ambient temperature must not be less than 16°C (60.8°F).
  - ▶ Operate the unit only with glass lids.
  - ▶ Check the temperature (see→ chapter 4.1).
  - ▶ Stored goods must be checked by the operator in the case of power failure (temperature control).
  - ▶ Check regularly for foreign objects in the goods area. Incorrectly stored goods must be removed immediately.
  - ▶ Remove food residues, such as spilled liquids and packaging residues (see → chapter 10.1.1.1).
  - ▶ Regularly check that the glass doors are closed.



## 9.1 Loading

Access to the goods from the top.

The unit must only be loaded with goods when the temperature specified for the product has been reached. Temperature display (see → chapter 4.1). Loading is only permitted up to the load line indicated inside the cabinet (see → Fig.7).

Lower load line: A3, A4

Upper load line: A1, A2, A5



Fig.7: Load line

### NOTICE

- **Property damage** due to misuse.
  - ▶ Do not load when display shows „dEF“.

### CAUTION



Cutting injuries in the case of material breakage.
 

- ▶ Do not climb onto or into the device during loading.

### CAUTION



Falling objects. Impact injury. Cutting injury in the case of glass breakage.



- ▶ Do not place objects on the unit.

### CAUTION



Opening/Closing the glass doors. Hands (body parts) can be pinched.
 

- ▶ During opening/closing, do not grip the gaps.
- ▶ When opening/closing, pay attention to other people.

### CAUTION



Low temperature. Frostbite on skin.
 

- ▶ Wear protective gloves during loading.



### NOTICE

- **Property damage** due to misuse.
  - ▶ The unit must only be loaded with goods when the temperature specified for the product has been reached.
  - ▶ Insert the goods carefully.
  - ▶ Immediately close the glass doors after loading.

## 9.2 Decommissioning and Re-commissioning

### WARNING



Work on the electrical system. Contact with live parts may cause electric shock.
 

- ▶ Work on the electrical system may only be performed by qualified staff.
- ▶ Observe the electrical safety rules before starting work.



1. Disconnect the unit.
2. Secure the unit against restarting.

### Reasons for decommissioning by qualified staff:

- Maintenance, service, repair (see → chapter 10.2)

### by operating staff:

- Damage to the unit (e.g. broken glass lids).

## 9.2.1 Decommissioning

The decommissioning must only be performed by trained **operating staff or qualified staff**.

### WARNING



Decommissioning of the unit. Contact with live parts may cause electric shock.

- ▶ Only previously trained staff must turn off the unit.



- ▶ Disconnect the unit and secure against restarting.

### Steps for decommissioning for operating staff:

1. Transfer the goods to another unit.
2. Switch refrigeration function off (see → chapter 4.2).
3. Remove the power plug (disconnect the unit).

### Prolonged decommissioning:

- Perform steps for decommissioning (see → above).
- Perform basic cleaning (see → chapter 10.1.1).
- Keep the lids open.

### NOTICE

- **Material damage** due to prolonged decommissioning.
  - ▶ Do not expose the unit to any direct heat radiation.
  - ▶ Do not place objects in or on the unit.
  - ▶ Store the unit only in the position of use.

## 9.2.2 Re-commissioning

See commissioning → chapter 8

## 9.3 Faults in operation

### Indication of alarms:

There are different types of alarms to indicate faults in operation:

### Display operating element:

**Electronic controller** (see → chapter 4.2.1):

- Error code and buzzer (optional)
- luminous red dot

### NOTICE

**Material- und property damage** in case of indication by error code/buzzer, luminous red dot.
 

- ▶ Move the goods to another unit.
- ▶ Contact the maintenance service (see → chapter 10.4) immediately.

Remote monitoring can be requested at the maintenance service (see → chapter 10.4).

## 10 Maintenance

Monitoring tasks by operating staff:

Monitoring tasks	Frequency	see → chapter
Check - good condition of the unit - foreign objects in good area - closed glass lids	continuously	1.3, 9
Check - Damage of glass lids/ glass elements - Damage of glass containers	continuously	1.6.3, 9
Check Temperature	several times daily	4.1, 9
Check correct loading of goods	continuously	9.1
<b>Check for contamination</b>		
- Contamination of the unit - Food waste and packaging waste	daily	10.1.1
Floor (around the unit)	daily	10.1.1
Puddle formation in front of/under the unit (defrost water)	daily	3.1
Defrost water drain/ sieve	continuously	10.1.1

### ⚠ WARNING



Electrostatic discharge and sparking. Sparks can ignite the leaking refrigerant when the refrigerant circuit is damaged/not sealed. Risk of fire.

- ▶ To remove water and for cleaning, use a slightly damp cloth or sponge.
- ▶ Do not use dry clothes or sponges to wipe dry (risk of electrostatic charging and sparking).
- ▶ Do not operate any electrical devices (e.g. wet vacuum cleaners) within the refrigerator compartment that are not of the type recommended by the manufacturer. Devices with explosion protection markings (see → chapter 1.2) are permitted.

### 10.1 Cleaning

Reasons for regular and thorough cleaning (basic cleaning):

- Assurance of the required hygiene.
  - ▶ Always keep the goods interior in a clean condition.
- Lowest possible energy consumption.
- Trouble-free operation.
- Life- time extension.

### ⚠ WARNING



Damage to the electrical system and refrigerant circuit by using steam and high-pressure cleaners. Contact with live parts may cause electric shock. The refrigerant can escape and create an explosive gas/air mixture. Risk of fire due to sparks or overloading.

- ▶ For basic cleaning, do not use steam



and high-pressure cleaners (→ see chapters 1.6.1 and 1.6.2.1).

### ⚠ CAUTION



Cutting injuries in the case of material breakage.  
Danger of falling.  
▶ Do not climb onto or into the unit during cleaning.

Safety in handling with glass see →chapter 1.6.3. For cleaning use protective gloves.

#### 10.1.1 Basic cleaning

**Responsibility:** Operating staff

**Cleaning agent:**

#### NOTICE

- **Material damage** due to excessive amounts of cleaning agents.
  - ▶ Use only cleaning devices moistened with cleaning agents.

Cleaning agents	Cleaning area
Clean water	Unit and glass surfaces outside and inside
Slightly alkaline cleaning agent for heavier contamination (e.g. neutral soap and water).	Unit outside and inside Glass surfaces outside
<b>Glass cleaner</b> (recommended pH-value 5-7)	Glass surfaces outside

#### NOTICE

- **Material damage** due to wrong cleaning agents.
  - ▶ Do not use abrasive, chemically aggressive, strongly acidic (pH-value <4), strongly alkaline (pH-value > 8) or highly flammable cleaning agents.

**Cleaning devices:**

All cleaning devices must be clean themselves.

Cleaning devices	Cleaning area
<b>For cleaning</b>	
Damp soft cotton cloth	Unit and glass surfaces outside and inside
Damp sponge cloth or sponge	Unit inside
<b>For drying</b>	
Lightly moistened soft cotton cloth	Unit and glass surfaces outside and inside

#### NOTICE

- **Material damage** due to wrong cleaning devices. Damage to the surfaces.
  - ▶ Never use hard, sharp objects.
  - ▶ Never use hard, coarse cleaning devices (e.g. steel wool).

#### 10.1.1.1 Cleaning steps during operation

**Frequency of cleaning (during operation):**

If needed (see → chapter 10 „check for contamination “).

**Cleaning steps:**

1.	Clean exterior walls and the frame.
2.	If available clean the bumpers and water protection strips.
3.	Clean glass surfaces outside.
4.	Remove food residues, such as spilled liquids and packaging residues.
5.	Clean the tracks for the lids.
6.	Dry all cleaned surfaces and components.
7.	Clean the floor in front of the unit.

**10.1.1.2 Cleaning steps only with cooling function switched off (manual defrost)**

**Frequency of cleaning (cooling function switched off):** For hygiene reason at least twice a year.

1.	Move goods to another unit.
2.	Switch refrigeration function off.
	Press Button <b>[STANDBY RESET]</b> for at least 3s. „---“ is shown at the display. See → chapter 4.2.1.1
3.	Removal of glass lids (see → chapter 7). Clean before re-installation. Also clean the associated plastic bezels/unit frame and seals. Do not apply large amounts of cleaning agent to these surfaces. <b>NOTICE</b> • <b>Material damage</b> due to improper cleaning. Damage to the surface of plastic bezels/unit frame and impairment of the function of seals. ▶ There must not be any detergent residues on the plastic bezels/unit frame and seals. ▶ Always clean plastic bezels/unit frame and seals again with clean water.
4.	Remove all accessories from the interior of the unit such as: air ducts, goods grilles. After use ensure for a neat and safe storage. Air-flow channel remains in the unit. Clean before re-installing. Wait until all ice and frost is melted from the inner walls of the tank.
5.	Remove defrost water (either by method 5a or 5b)
5.a	- Wet vacuum cleaner / electrical devices with marking of explosion protection or - Lightly moistened cloth (observe warning notice see → chapter 10).
5.b	Units with defrost water plug - Place a pan under the drain. - Remove the defrost water plug. - Let the defrost water drain off - Close the drain with the defrost water plug again.
	 defrost water plug

Fig.8: Unit with view on defrost water plug

6.	Remove food residues, such as spilled liquids and packaging residues
7.	Clean the interior of the unit - Clean the defrost drain - Remove and clean the defrost water sieve  Fig.9: Defrost water drain/sieve
8.	If needed clean the air-flow channel (see → Fig. 10), for this purpose lift the air-flow channel up and clean the areas below carefully with a moistened cloth.  Fig.10: Air-flow channel
9.	All cleaned areas and components must be dried again. Observe warning notice see → chapter 10).
10.	Re-install all accessories correctly.
11.	Re-install the lids properly (see → chapter 7) and close them completely.
12.	Switch refrigeration function on. Press Button <b>[STANDBY RESET]</b> for at least 3s. The temperature is shown at the display. See → chapter 4.2.1.1

**NOTICE**

- **Property damage** due to misuse.  
▶ The unit must only be loaded with goods when the temperature specified for the product has been reached.

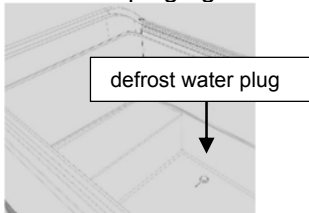
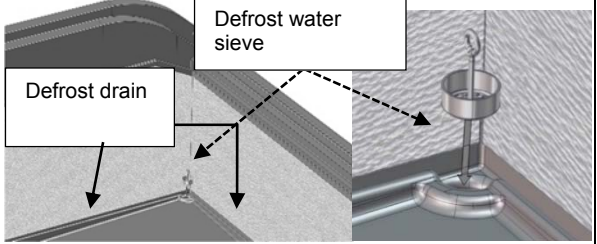
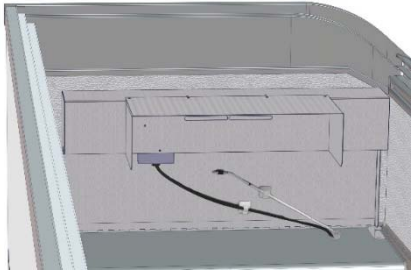
**10.2 Maintenance, service and repair**

**Responsibility:** qualified staff

The units are maintenance-free. The service and repair work, including subsequent functional testing, must be performed by qualified staff. For questions about maintenance, please contact the maintenance service (see → chapter 10.4).

**⚠ WARNING**



Work on the electrical system and refrigerant circuit. Contact with live parts may cause electric shock. The refrigerant can escape and create an explosive gas/air mixture. Risk of fire due to sparks or overloading.  
▶ Work on the electrical system and refrigerant circuit may only be performed by qualified staff.

- ▶ Follow the safety instructions in → chapter 1.6.
- ▶ Before any maintenance, service and repair work.



1. Disconnect the unit.
  2. Secure the unit against restarting.
- ▶ Re-commissioning and functional testing must only be performed by qualified staff.

**⚠ CAUTION**



Sharp edges, rotating parts. Risk of injury to the hands and body.  
Hot surfaces. Risk of burns in case of skin contact.



▶ Service and repair work on the unit must only be performed by qualified staff.



- ▶ Wear protective gloves.
- ▶ Touch hot surfaces (especially compressor) only after cooling.

### 10.3 What to do if ...

All units are thoroughly tested for performance and safety in the AHT testing center.

Immediately contact the maintenance service (see → chapter 10.4), if:

- a fault occurs (see → chapter 9.3),
- loud noises or vibrations occur,
- failure of the operating- and display elements (see → chapter 4.2.1.4)

Report the following:

- Unit type
- Serial number of the unit (see serial plate → chapter 2.2.1/additional sticker on the left frame backside see → Fig.11),
- Type of fault.



Fig.11. Example, sticker with 14-digit serial number

### 10.4 Maintenance services

For questions regarding maintenance (service, repair, etc.), please contact your regionally competent **AHT service partner**:

AHT-service line: 00800/73783248  
 Online-contact: [www.aht.at/service](http://www.aht.at/service)  
 QR-Code:



The maintenance services have access to all necessary and current information for commissioning and maintenance, e.g. spare parts lists.

## 11 Disposal

**⚠ WARNING**



Escaping refrigerant or residues of refrigerant can create an explosive gas/air mixture. Risk of fire.

- ▶ Do not damage the pipes.
- ▶ Open the refrigerant circuit correctly before dismantling and disposal and suction off the refrigerant safely and completely. There must not be any residues left in the refrigerant circuit.
- ▶ Suctioning off of refrigerant must only be performed by qualified staff.

**⚠ CAUTION**

Improper disposal. Environmental damage.

- ▶ Pay special attention to safe and environmentally sound disposal
  - of the refrigerant,
  - of the insulating foam (e.g. heat-insulating material is polyurethane foam with pentane),
  - of the compressor oil,
  - of the battery



- ▶ Separate collection of electrical and electronic devices according to the applicable national disposal regulations (e.g. WEEE within the EU) and the provisions of the local waste disposal partner.
- ▶ Units must not be disposed of with household waste.

---

**AHT Cooling Systems USA, Inc.**

7058 Weber Blvd. • Ladson, SC 29456 • USA

**Phone:** +1 (0) 843/767 6855 **Fax:** +1 (0) 843/767 6858 **Email:** [info@us.aht.at](mailto:info@us.aht.at) **Internet:** [www.ahtusa.net](http://www.ahtusa.net)

**AHT Cooling Systems GmbH (Headquarter)**

8786 Rottenmann • Werksgasse 57 • Austria

**Tel:** +43 3614 2451 0 **Fax:** +43 3614 2451 8 **Email:** [office@aht.at](mailto:office@aht.at) **Internet:** [www.aht.at](http://www.aht.at)

**AHT Cooling Systems Brasil Ltda.**

Rua Onório Bortolato • 1065–Bairro Pedreiras Navegantes – SC - 88375-000 • Brasil

**Phone:** +55 (0) 11 4702 / 30 99 **Fax:** +55 (0) 11 4702 / 71 68 **Email:** [info@br.aht.at](mailto:info@br.aht.at)

**AHT Cooling Systems (Changshu) Co., Ltd.**

215500 Changshu • 88 Yangguang Avenue

Jiangsu Province • P. R. China

**Phone:** +86 512 5236 7100 **Fax:** +86 512 5236 2393 **Email:** [office@cn.aht.at](mailto:office@cn.aht.at)